

> BIL740T

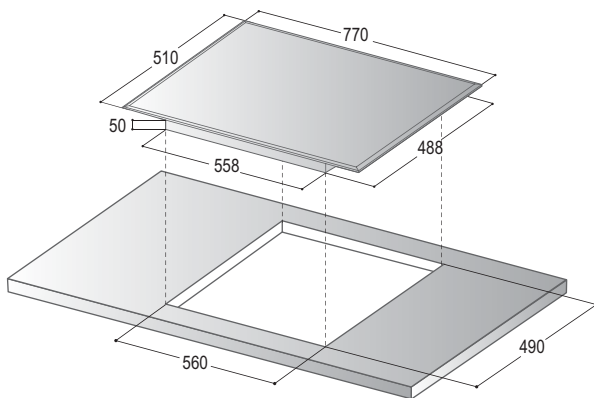

Max. Absorption: 7,2 kW

