

> BCF742PE

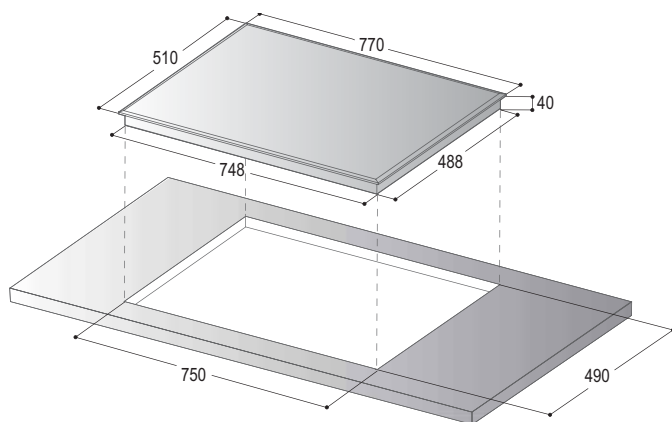

Max. Absorption: 7,2 kW

